

"QUALITY PUMPS SINCE 1939"

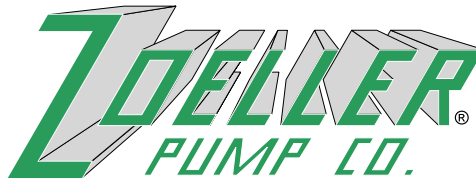

SECTION: 2.60.040

FM2335

0705

Supersedes

New

Product information presented here reflects conditions at time of publication. Consult factory regarding discrepancies or inconsistencies.

MAIL TO: P.O. BOX 16347 • Louisville, KY 40256-0347
 SHIP TO: 3649 Cane Run Road • Louisville, KY 40211-1961
 (502) 778-2731 • 1 (800) 928-PUMP • FAX (502) 774-3624

visit our web site:
www.zoeller.com

DRAIN PUMP SERIES

104* - 105 - 110 - 115 - 120 - 131

Model 132* (Preassembled)

Removes water from areas where gravity flow is not available.

Applications include, laundry tray pump, wet bar sink, lavatory, air conditioning condensate or dehumidifier water removal. It can also be used in conjunction with dishwashers and garbage disposal applications.

Internal Trap**

Lavatory Sink

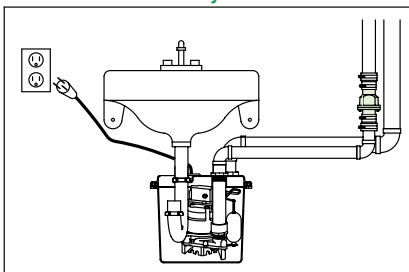

Wet Bar With Sink

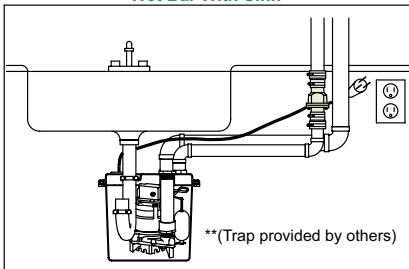

** (Trap provided by others)

Laundry Tray Pump

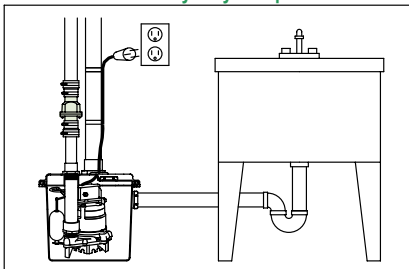

Dehumidifier or Air Conditioner

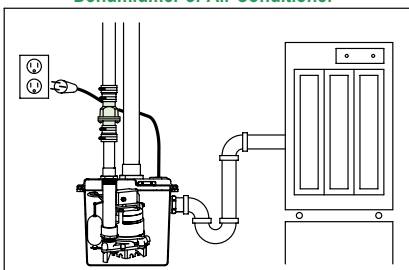

Standard Installation

NO INLET FILTERS OR SCREENS TO CLEAN



*Models 104 & 132 are not IAPMO approved.

NEW!
 CAN BE
 INSTALLED WITH
 INTERNAL
 TRAP



NEW!
 OPTIONAL INLET
 TOP / SIDE

Product may not be exactly as pictured.

DRAIN PUMP SERIES INCLUDES:

- Automatic pumps with tank cord seals and all hardware for easy assembly.
- Polypropylene basin and lid.
- Internal discharge pipe to lid. (Trap supplied by others)**
- Check Valve (30-0181, not included with model 104).

DRAIN PUMP SERIES

104*
 105
 110
 115
 120
 131
 132*

MODEL PUMP WITH BASIN

M72
 M53
 M55
 M57
 M59
 M98
 M72

SHIPPING WT.

19 lbs.
 30 lbs.
 33 lbs.
 35 lbs.
 38 lbs.
 47 lbs.
 19 lbs.

SK2011

*Models 104 & 132 are not IAPMO approved.

© Copyright 2005 Zoeller Co. All rights reserved.

COMPARE THESE FEATURES

PUMP FEATURES

(Models 53-55-57-59-98)

- Passes laundry lint.
- Automatic, float operated mechanical switch.
- 115 V/1 PH, all Drain Pump Series.
- 9 ft. UL Listed 3-wire cord and plug. (15 ft. cord std. on model 98)
- Stainless steel screws, guard, handle and switch arm.
- Passes 1/2" spherical solids.
- 1 1/2" NPT discharge.
- 1550 RPM, 60 Hz. 1725 RPM on model 98.
- Non-clogging vortex impeller.
- Glass-filled polypropylene base with built in strainer on M53 and M55. Model 59, all bronze construction; model 57 & 98 all cast iron construction.
- Temperature rated 130°F.
- UL Listed Pump.

(Model 72)

- Passes laundry lint.
- 115 V/1 PH, all Drain Pump Series.
- 9 ft. UL Listed 3-wire cord and plug.
- Stainless steel screws, switch arm and lower motor housing.
- Oil free.
- Passes 3/8" spherical solids.
- 1 1/2" NPT discharge.
- 3400 RPM.
- Non-clogging vortex impeller.
- Temperature rated 110°F.
- cCSAus Certified Pump.

BASIN

- Polypropylene construction.
- Corrosion resistant.
- High capacity.
- Gasket sealed polypropylene lid.
- 2" NPT vent.
- 1 1/2" NPT discharge.
- 1 1/2" compression slip fit for top and side intake. NOTE: 132 comes preassembled for side inlet only.
- Threaded connections for easy installation.
- May be installed with internal trap for space savings.
- Gas tight cover.
- Temperature rated 130°F.
- Fits under most sinks.
- Basin Passes 10' Stack Test.*

*Models 104 and 132 will not pass 10' Stack Test

CHECK VALVE(excluding Model 104) (30-0181)

- "Full Flow" design.
- 1 1/2" or 1 1/4" slip x slip union.
- PVC construction.

For additional specifications see FM0217.

NOTE: For additional inlet option or high head applications contact factory.

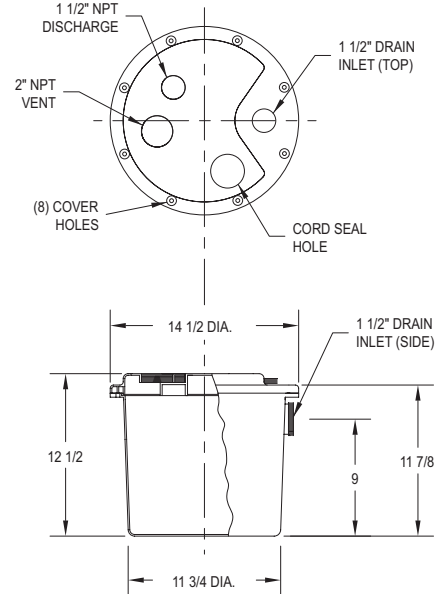

SK2012

EASY INSTALLATION - NO NEED TO DIG A SUMP.



WARNING TO REDUCE THE RISK OF ELECTRICAL SHOCK A PROPERLY GROUNDED RECEPTACLE OF GROUNDING TYPE SHALL BE INSTALLED AND PROTECTED BY A GROUND FAULT CIRCUIT INTERRUPTER (GFCI) IN ACCORDANCE WITH NATIONAL ELECTRICAL CODE AND LOCAL CODES. DO NOT REMOVE GROUND PIN FROM PLUG.

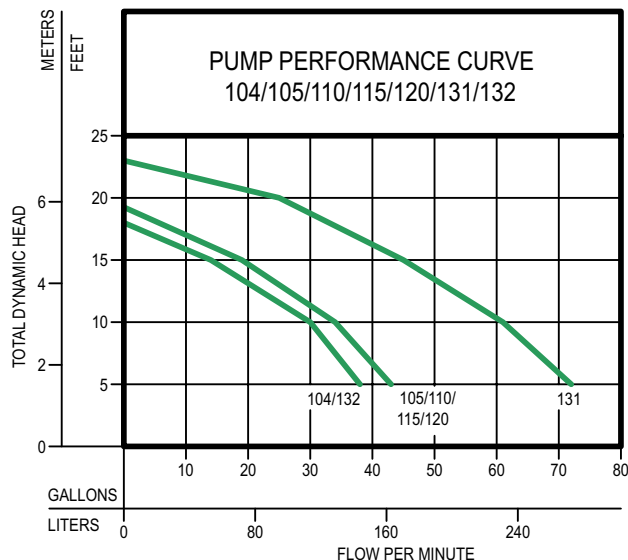

MODELS	104/132		105/110 115/120		131		
	Feet	Meters	Gal.	Liters	Gal.	Liters	
5	1.5	38	144	43	163	72	273
10	3.0	30	114	34	129	61	231
15	4.6	14	53	19	72	45	170
20	6.1	--	--	--	--	25	95
Shut-off Head:		18 ft. (5.5m)		19.25 ft. (5.9m)		23 ft. (7.0m)	

009898

DRAIN PUMP MODEL	REPLACEMENT PUMP PART NUMBER
104	72-0001
105	007917
110	007918
115	007919
120	007920
131	007921
132	72-0001

RESERVE POWERED DESIGN

For unusual conditions a reserve safety factor is engineered into the design of every Zoeller pump.

© Copyright 2005 Zoeller Co. All rights reserved.