

# Wastewater

## 6 Series



### Applications

- Little Giant 6 Series Sump Pumps are rated for continuous duty in basement sump, dewatering and water transfer applications

### Features

- 1/3 hp shaded pole motor with thermal overload protection
- Oil-filled motor housing
- Cast iron pump housing with protective epoxy coating for corrosion resistance
- 1-1/2" FNPT discharge
- Stainless steel screws, bolts and handle
- Mechanical seal (stainless steel spring, nitrile parts, carbon and ceramic faces)
- Upper and lower sintered sleeve bearings
- Manual and automatic models
- PVC leg kit lifts the pump off the bottom of the basin to help keep the intake screen free of debris (Included with item 506162 only)
- Automatic operation with integral diaphragm switch:
  - On level: 7" - 10"
  - Off level: 1" - 4"  
(Integral diaphragm switch is non-adjustable)
- Automatic operation with piggyback mechanical float switch:
  - On level: 9" - 10.5"
  - Off level: 2" - 3"  
(Pumping range is adjustable)

## Engineering Data

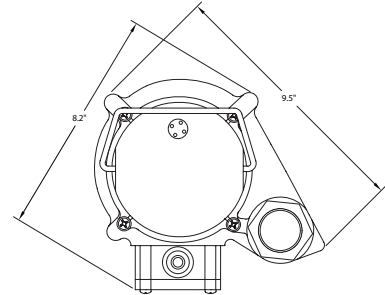
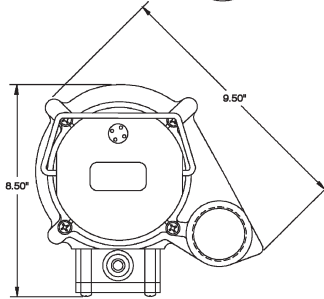
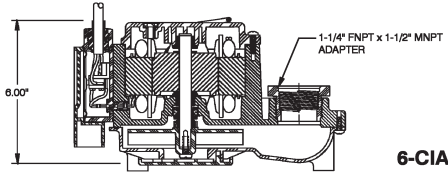
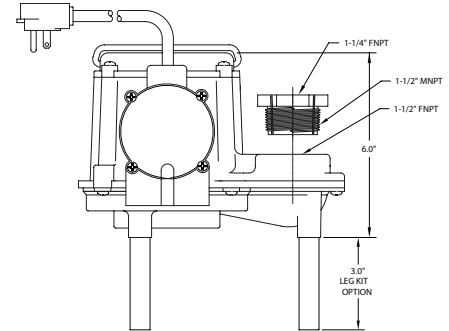
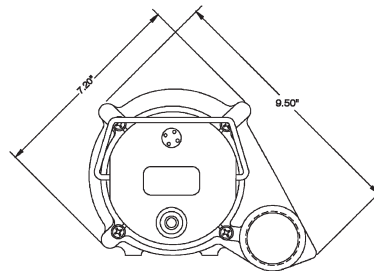
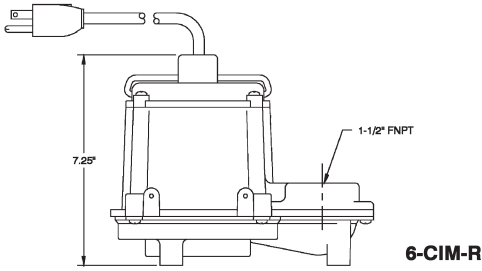

## Specifications

Item No.	Model No.	Listing	HP	Volts	Amps	Watts	Flow (GPM @ Head)			Shutoff Head (ft)	P.S.I.	Power Cord (ft)	Weight (lbs)	Dimensions (H x L x W) (in)
							5'	10'	15'					
506271	6-CIM-R	cCSAul	1/3	115	9.0	720	46	29	12.5	18	7.8	10	16.50	7.25 x 9.50 x 7.25
506274	6-CIM-R	cCSAul	1/3	115	9.0	720	46	29	12.5	18	7.8	25	18.00	7.25 x 9.50 x 7.25
506125	6-CIA	cCSAul	1/3	115	9.0	720	46	29	12.5	18	7.8	25	18.50	6.00 x 9.50 x 8.50
506267	6-CIA-RS*	cCSAul	1/3	115	9.0	720	46	29	12.5	18	7.8	10	17.50	7.25 x 9.50 x 7.25
506266	6-CIM	—	1/3	230	4.5	720	46	29	12.5	18	7.8	12	18.75	6.00 x 9.50 x 8.50
506158	6-CIA	cCSAul	1/3	115	9.0	720	46	29	12.5	18	7.8	10	18.00	6.00 x 9.50 x 8.50
506162	6-CIA***	cCSAul	1/3	115	9.0	720	46	29	12.5	18	7.8	10	18.50	6.00 x 9.50 x 8.50
506166	6-CIA	cCSAul	1/3	230	4.5	720	46	29	12.5	18	7.8	10	18.50	6.00 x 9.50 x 8.50
506171	6-CIA-RFS**	cCSAul	1/3	115	9.0	720	46	29	12.5	18	7.8	10	17.75	7.25 x 9.50 x 7.25

All models are 60 Hz CIM - Manual CIA - Automatic

\*Manual pump with RS-5 diaphragm switch included to convert to automatic operation.

\*\*Manual pump with piggyback mechanical float switch included for automatic operation.

\*\*\*Includes PVC leg kit

Continuous Duty Rated — "Little Giant Wastewater pumps are rated continuous duty as long as they are run within the published ratings for these pumps."

## Construction

Cover	Polycarbonate
Motor Housing	Epoxy coated cast iron
Impeller Material	Nylon
Impeller Type	Non-clog
Volute	Polypropylene
Power Cord	18-3, SJOW-A
Mechanical Shaft Seal	Nitrile with carbon and ceramic faces
Fasteners	Stainless steel
Shaft	CRS
Bearings	Upper: Sintered iron/copper, flanged sleeve Lower: Sintered iron/copper, flanged Sleeve

## Performance Data

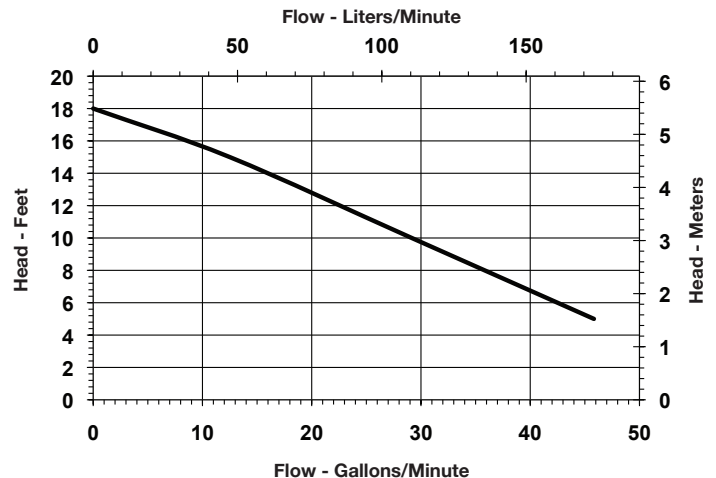

P.O. Box 12010  
Oklahoma City, OK 73157-2010  
Phone: 1.800.701.7894  
Fax: 1.800.678.7867  
www.LittleGiantPump.com



©2010 Franklin Electric Co., Inc.  
Little Giant® is a registered trademark of Franklin Electric Co., Inc.  
Form 995201 — 06/11